



Tab-tensioned Dual Format Electric Projection Screen

VMAX Tab-Tension Dual Series

User's Guide

Important Safety & Warning Precautions

Make sure to read this user's guide and follow the procedure below.

Caution: The Screen's Black Top Drop is already set to its maximum drop distance. There is NO extra top Black Drop in the roller. Please be aware of this. Any attempts to increase the top black drop will void your warranty with Elite Screens. Unapproved changes or modifications (except for cutting the power cord for hardwire installations) to this unit are prohibited and will void your warranty. For more information, please contact our Technical Support Department at techsupport@elitescreens.com

- Please retain this user's guide for future reference.
- To avoid damaging the unit, do not use with any unauthorized accessories not recommended by the supplier.
- Handle the unit carefully during transportation to avoid any damages.
- To ensure safe and reliable operation, direct connection to a properly grounded power source is advised.
- The power outlet supplying power to the unit should be close to the unit and easily accessible.
- Do not install the unit on uneven or inclined surfaces.
- Do not place any heavy objects over the power cord.
- Position the power cord properly to avoid creating a trip obstacle.
- To avoid an electrical shock or fire due to a loose contact or short circuit, do not overload the power cord.
- The internal & external parts of this unit are not end user serviceable. Do not attempt to disassemble this unit by yourself. No one except authorized technicians can open and make repairs to this unit.
- Make sure the power source that this unit is connected to has a continuous power flow.
- If there is need to use an extension cord, make sure the cord has an equal rating as the appliance to avoid over heat.
- Do not handle the power plug when your hands are wet or your feet are in contact with water.

Do not use this unit under the following circumstances:

- Disconnect the power cord under the conditions of heavy rain, wind thunder or lightning.
- Avoid direct sun light, rain shower and moisture.
- Keep away from fire sources and high temperature to prevent this device from overheating.
- Cut off the power supply first before transportation or maintenance.
- To avoid possible injury and/or an electric shock, do not attempt to use this screen if there is obvious damage or if there are any evident broken parts.

Installation Warning

The instructions provided in this user's guide are for reference only. Regardless of the mounting method, the screen should be securely supported so that vibrations or pulling on the viewing surface will not cause the casing to become loose or fall. The installer must insure that proper mounting hardware and fasteners are used to provide adequate strength suitable for the installation. Elite Screens is not liable for any faulty installations.

Individual modifications to this product are prohibited and will void the warranty with the supplier. Please contact Elite Screens Customer Service for any questions.

NOTE:

This equipment has been tested and found to comply with the limits for a Class B digital device, pursuant to Part 15 of the FCC Rules.

These limits are designed to provide reasonable protection against harmful interference in a residential installation. This equipment generates and can radiate radio frequency energy and, if not installed and used in accordance with the instructions, may cause harmful interference to radio communications.

However, there is no guarantee that the interference will not occur on a particular installation. If this equipment causes harmful interference to radio or television reception, which can be determined by turning the equipment off and on, the user is encouraged to try to correct the interference by one or more of the following measures.

- ✓ **Reorient or relocate the receiving antenna of the device which may be causing the interference.**
- ✓ **Increase the separation between the screen and the device's receiver.**
- ✓ **Connect the equipment into a different power outlet other than the device.**

Pre-Installation

1. Carefully unpack the screen.
2. Always handle the screen in a leveled position on a clean surface.
3. In order to protect the screen from exposure to stains, keep the screen out of contact with foreign particles such as dust, sawdust, and/or liquids.

Accessories for VMAX Tab-Tension Dual Series

Please make sure all accessories listed below are included before proceeding.

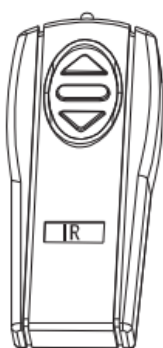

A. IR Remote

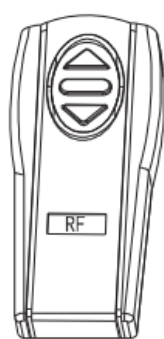

B. RF Remote



C. 3-way wall switch



D. IR eye receiver



E. 5-12v trigger cable

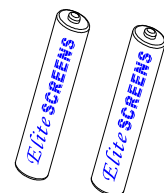

F. AAA batteries

Control System for VMAX Tab-Tension Dual Series

The VMAX Tab-Tension Dual Series features the capability of alternating 16:9 HDTV and 2.35:1 Cinemascope projection screen formats, which are operated with the included Radio Frequency & Infrared Remote Controls or the 3-way Wall Switch. The dual motors and screen materials allow you to utilize both formats. An Infrared sensor is not built into the case. The IR "Eye" Receiver must be connected to the RJ-45 input to operate the screen with the Infrared Remote Control.

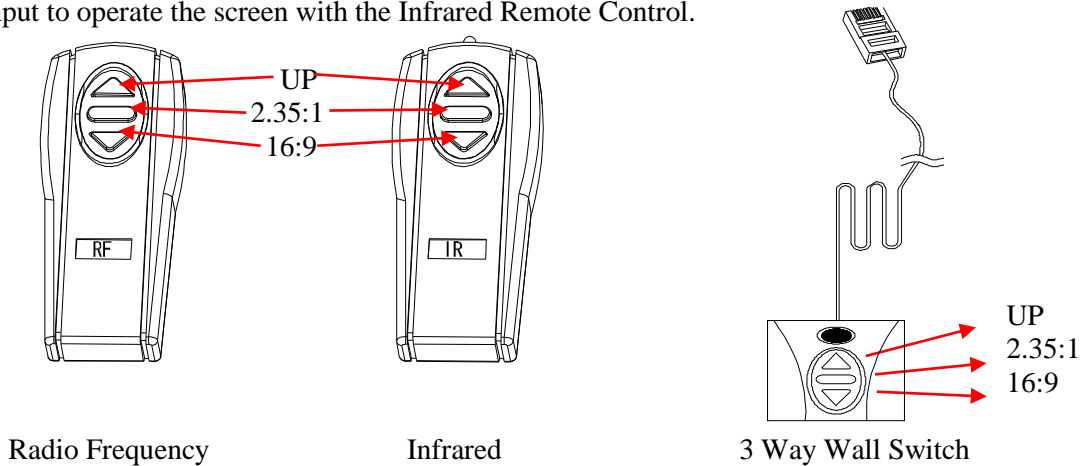

1. Ensure the VMAX Tab-Tension Dual screen is plugged into a secure power source as shown below.

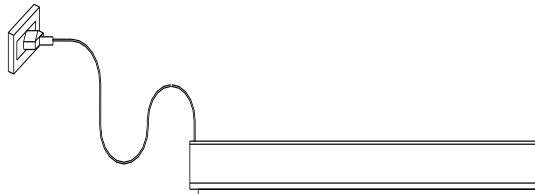

2. **2.35:1 Cinemascope:** Press the 2.35:1 button on the Radio Frequency remote, Infrared remote or the 3 Way Wall Switch to lower and display the 2.35:1 Cinemascope format.

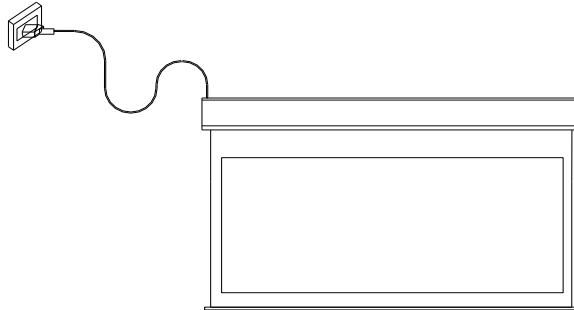

3. **16:9 HDTV:** Press the 16:9 button on either of the optional controls and the 2.35:1 format screen will retract into the housing while the 16:9 format deploys.

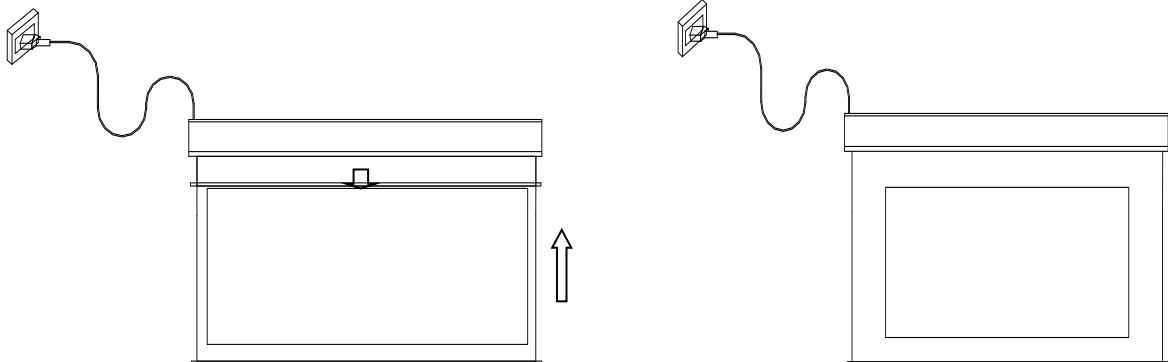

4. Press the “UP” button on either of the control options and the screen will completely retract.



Hardware Parts List for VMAX Tab-Tension Dual Series

Please make sure all items listed below are included before proceeding with the installation.

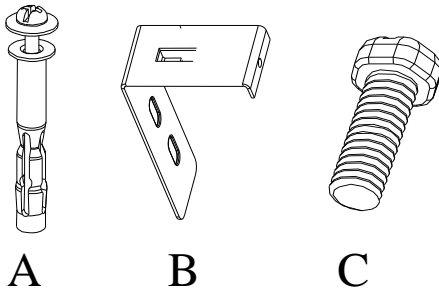

Hardware Parts List		QTY
A. Wood Screw & Hollow Anchor		8
B. Mounting Bracket		4
C. M4 Screw		4

Installation Instructions

Elite Screens is not liable for any faulty installations. The VMAX Tab-Tension Dual Screen is designed for a wall or optional in-ceiling installation. Hardware for a wall installation is provided, please contact Elite Screens for information about our optional in-ceiling trim kit.

1. Make sure the current rating is equal to that of the appliance rating when an extension cord is used.
2. Do not use any accessories not provided by the supplier of this screen. We will not be responsible for any risks of fire, electric shock, or injuries resulting from the misuse of this product.
3. Make sure the screen is mounted in a horizontal level position.
4. Mark the location of where the screen is to be installed and drill your holes. Align the **Mounting Bracket (B)** with the drilled hole, insert the **Screw (A)** and secure.

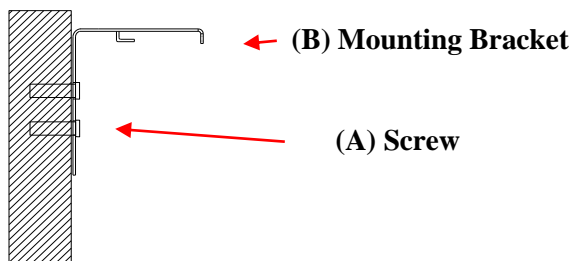

5. Insert the top of the screen into the **Mounting Bracket's (B)** slide channel and move to the desired position.

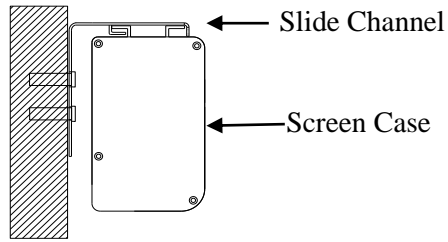

6. Secure the screen case to the bracket with the **M4 Screw (C)**.

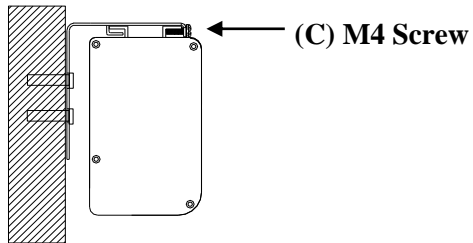

For a local Elite Screens contact or Technical Support, please visit
www.elitescreens.com