



Yard Master Electric 150” and Above Yard Master Electric Tab-Tension Series [Outdoor Electric Movie Projector Screen](#)

User's Guide

*Thank you for choosing the **Yard Master Electric / Yard Master Electric Tab-tension Series** projection screen! Please read through this user guide before utilizing the screen. Correct usage and maintenance will ensure a long product life*

Product Description:

The **Yard Master Electric** is an outdoor projector screen for wall and patio installations that brings media room quality to your outdoor spaces. Its sleek aluminum casing beautifully accessorizes your backyard, patio, pool deck or anywhere a gathering for evening movie time is appropriate.

Outdoor Projection Screen Disclaimer

Never leave your projection screen out and exposed to direct sunlight. Regardless of screen brand, prolonged exposure to the sun's ultraviolet radiation degrades the chemical bonds causing the material to eventually decompose. Photodegradation first causes the material to lose its theater-grade reflective qualities. Eventually nature will destroy even synthetic materials. For this reason, the **Yard Master Electric** has a retractable design that allows the material to be drawn up into its protective casing to be shielded from solar radiation.

Care & Use Instructions

◆ Dust, dirt and scratches on the projection surface will affect the picture quality, please take note of the points below to prevent that from occurring:

1. Do not touch the projection surface with your hands
2. Do not write or draw on the projection surface
3. Do not use fingers or sharp objects to point on the projection surface; this will damage the screen material.
4. Use a soft-damp cloth to clean the projection surface; do not use chemical cleaning agents or alcohol.
5. Use clean water when dampening the cleaning cloth and do not rub against the material to clean it.

◆ To avoid damage and injury, the screen should only be operated by adults.

IP Rating Chart

1st Digit - SOLID

Degree of protection against solid objects

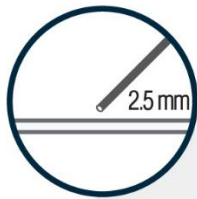

Protected against a solid object greater than 2.5mm, such as a wire.

3

2nd Digit - LIQUID

Degree of protection against water

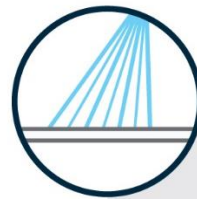

Protected against water spray at 60 degree angle.

3

Important Safety & Warning Precautions

Make sure to read this user's guide and follow the procedures below.

- Please retain this user's guide for future reference.
- To avoid damaging the unit, do not use with any unauthorized accessories not recommended by the supplier.
- Handle the unit carefully during transportation to avoid any damages.
- To ensure safe and reliable operation, direct connection to a properly grounded power source is advised.
- The power outlet supplying power to the unit should be close to the unit and easily accessible.
- Do not install the unit on uneven or inclined surfaces.
- Do not put heavy objects on the power cord and position it properly to avoid creating a trip obstacle.
- Never overload the power cord to prevent an electric shock or fire due to a loose contact or a short circuit.
- There are not user serviceable parts in this unit. Do not attempt to disassemble this unit by yourself. No one except authorized technicians can open and make repairs to this unit.
- Make sure the power source this unit is connected to has a continuous power flow.
- If there is need to use an extension cord, make sure the cord has an equal rating as the appliance to avoid overheating.
- Do not handle the power plug when your hands are wet or your feet are in contact with water.

Do not use this unit under the following circumstances.

- Disconnect the power cord under the conditions of heavy rain, wind, thunder or lightning.
- Avoid direct Sunshine, rain shower and moisture.
- Keep away from fire sources and high temperature to prevent this device from overheating.
- Cut off the power supply first before transportation or maintenance.
- Fully disconnect from the power supply when the unit is not in use for a long period of time, as should be done with any other electric household appliance.
- To avoid possible injury and/or an electric shock, do not attempt to use the screen if there is obvious damage or if there are any evident broken parts.

WARNING

The Screen's **Top Black Drop** is already set to its maximum drop distance. There is **NO** extra top black drop in the roller. Please be aware of this as it will void the limitation of your warranty.

Individual modifications to this product are prohibited and will void the warranty with the supplier. Please contact Customer Service for any questions.

NOTE:

This equipment has been tested and found to comply with the limits for a Class B digital device, pursuant to Part 15 of the FCC Rules.

These limits are designed to provide reasonable protection against harmful interference in a residential installation. This equipment generates and can radiate radio frequency energy and, if not installed and used in accordance with the instructions, may cause harmful interference to radio communications.

However, there is no guarantee that the interference will not occur on a particular installation. If this equipment causes harmful interference to radio or television reception, which can be determined by turning the equipment off and on, the user is encouraged to try to correct the interference by one or more of the following measures.

- ✓ **Reorient or relocate the receiving antenna of the device which may be causing the interference.**
- ✓ **Increase the separation between the screen and the device's receiver.**
- ✓ **Connect the equipment into a different power outlet other than the device.**

Pre-Installation







1. Carefully unpack the screen.
2. Always handle the screen in a leveled position on a clean surface.
3. In order to protect the screen from exposure to stains, keep the screen out of contact with foreign particles such as dust, sawdust, and/or liquids.

NOTE

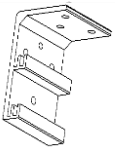
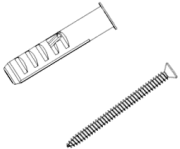
Wall screws included with this product are complimentary and may not be adequate for all mounting surfaces. Consult with a professional installer or hardware store for proper mounting screws and anchors.

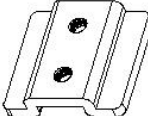
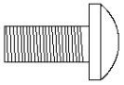
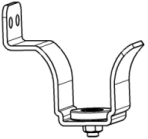
Regardless of the mounting method, the screen should be securely supported so that the vibration or pulling on the viewing surface will not cause the casing to become loose or fall. The installer must ensure that the fasteners used are of adequate strength and suitable for the installation location.

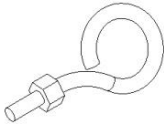
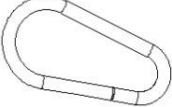
Hardware Parts List for Yard Master Electric Series

A. Wall/Ceiling mount bracket x 2 pcs	B. M5x60 screw & dry-wall anchor x 6pcs	C. M8x35 dry-wall anchor & M4x35 Screw x 4pcs	D. Bracket connector x 2 pcs (On the housing)	E. M5x11 Bolt Screw x 4pcs (Screw on Part D)
				
G. Magnetic weight bar bracket x 2pcs	H. M5x25MM round head cross screws x 2pcs	I. M5x30MM eyebolt screw & M5 nut x 2pcs	J. Snap link x 2pcs	K. Bubble leveler x 1pc
				

Installation Instructions

For installation assistance, please consult a professional Installer. Elite Screens' is not liable for faulty installations.

A. Wall Mount

Flush hidden mount (movable position)

This mount method allows the screen to slide horizontally.

Two or more people are required while one holds the screen in place.

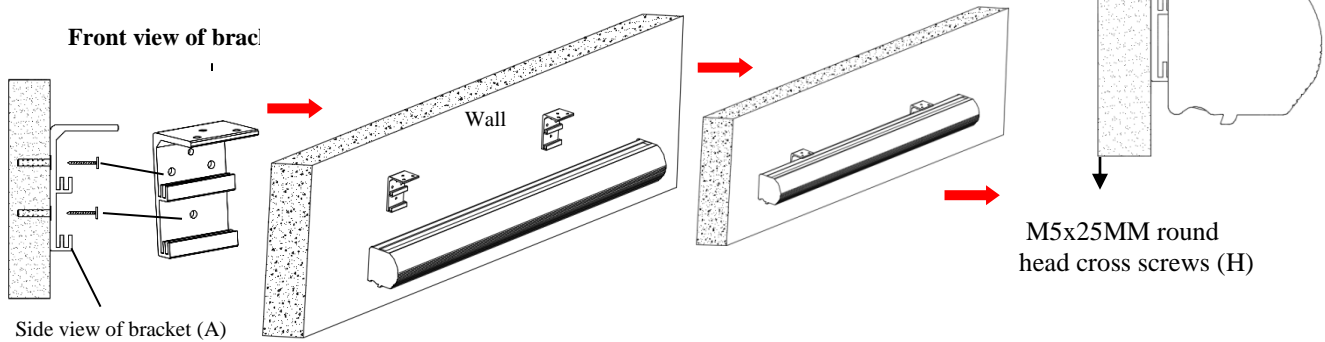

1. Determine where the screen will be installed. Then, measure and mark the distance between the top and bottom screw holes from each **Wall/Ceiling mount bracket (A)**.
2. Drill a hole on all marked areas and install the brackets with the **dry-wall anchor & M5x60 screw (B)**, Make sure both brackets are properly leveled.
3. Hang the screen by placing the **downward** “catch” located on the back over the brackets **upper** “catch”.
4. After making sure the screen is secured, you can slide it left / right to properly center it in position.
5. Lastly, screw the **M5x25mm screw (H)** into the upper hole of the bracket to add additional support for the screen.

B. Ceiling Mount

I. Ceiling Mount (movable position)

This mount method allows the screen to slide horizontally.

Two or more people are required while one holds the screen in place.

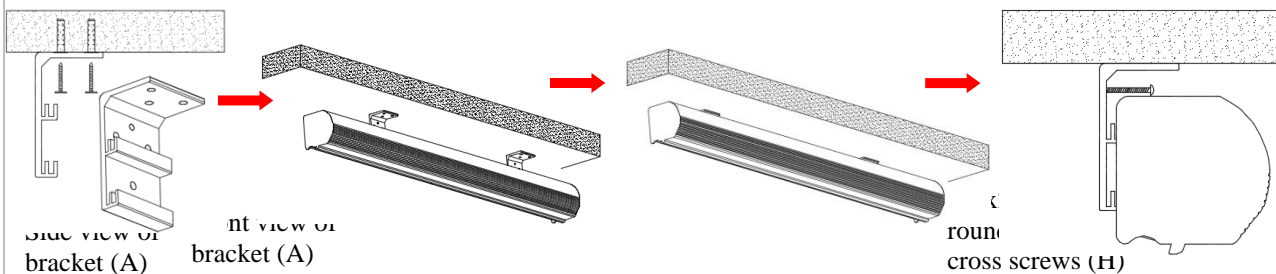

1. Determine where the screen will be installed. Then, measure and mark the distance between the top and bottom screw holes from each **Wall/Ceiling mount bracket (A)**.
2. Drill a hole on all marked areas and install the brackets with the **dry-wall anchor & M5x60 screw (B)**, Make sure both brackets are properly leveled.
3. Hang the screen by placing the **downward** “catch” located on the back over the brackets **upper** “catch”.
4. After making sure the screen is secured, you can slide it left / right to properly center it in position.
5. Lastly, screw the **M5x25mm screw (H)** into the upper hole of the bracket to add additional support for the screen.

II. Suspended

1. Screw the **eyebolt** (I) on the **bracket connector** (D).
2. Attach the **snap link** (J) through the **eyebolt** (I) and connect it to an eyebolt screw (not included) rated for the screen's weight.

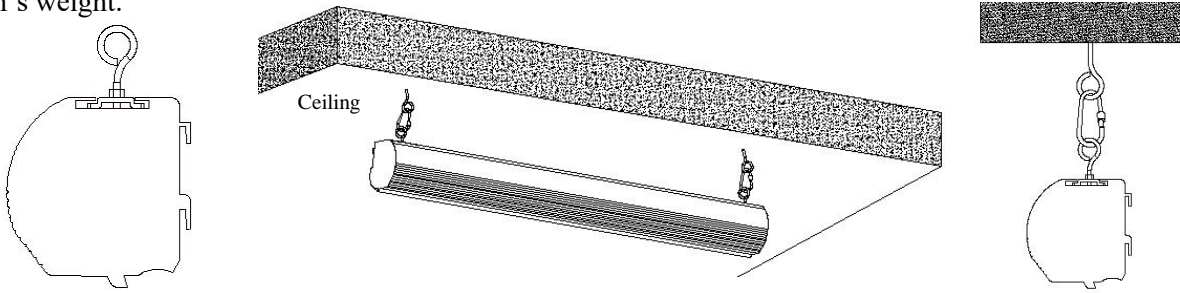

Yard Master Electric Control System and Operation

Yard Master Electric Series Controls

A. RF Remote Control x1 pc (Battery built-in)

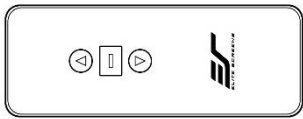

B. Wireless trigger x1 pc

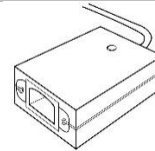

Screen operation

Electric Current: 110 voltage.

1. After ensuring the power outlet & screen are compatible (voltage), plug the power cord into the power outlet.
2. Once the screen has power, you'll be able to control it using any of the **2 methods** described below.

2 ways to control your Yard Master Electric Screen

1. **RF Remote Control** (Item A): The radio waves eliminate the need for a direct line of sight with a range of 100 feet.

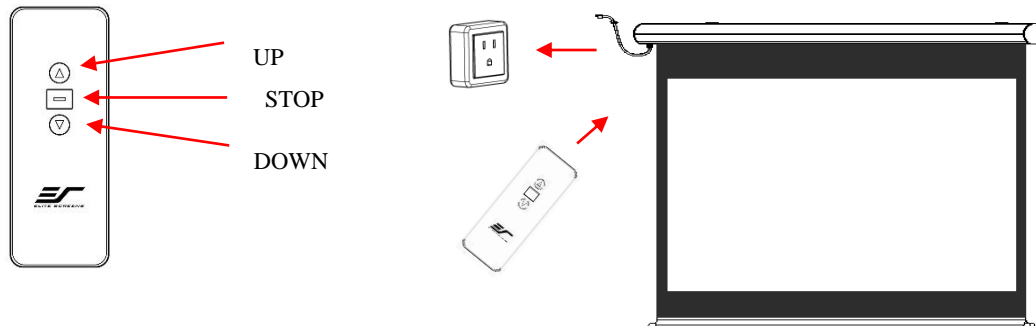

Radio Frequency (RF) Remote Synchronization Instructions

1. Make sure the screen's power cable is not plugged into a power outlet (If so, then unplug it).
2. Press and HOLD the UP button on the RF remote until you see the flashing light turn solid. (See diagram above)
3. While holding the UP button, plug the screen's power cable into the power outlet. The screen will drop slightly (you may hear a beep) indicating it has entered pairing mode.
4. Release the UP button for 3 seconds, then press UP button again until you see the flashing light turn solid (the screen will go up and down slightly).
5. You should now be able to control your electric screen with the RF remote control.
6. If unsuccessful repeat from Step 1.

Note: The beep(s) the screen produces are very faint. It may be difficult to hear, if more than 5 feet away from the screen.

2. **Wireless trigger (Item B):** The wireless trigger allows your screen to synchronize its drop/ rise operation with the projector's power cycle.

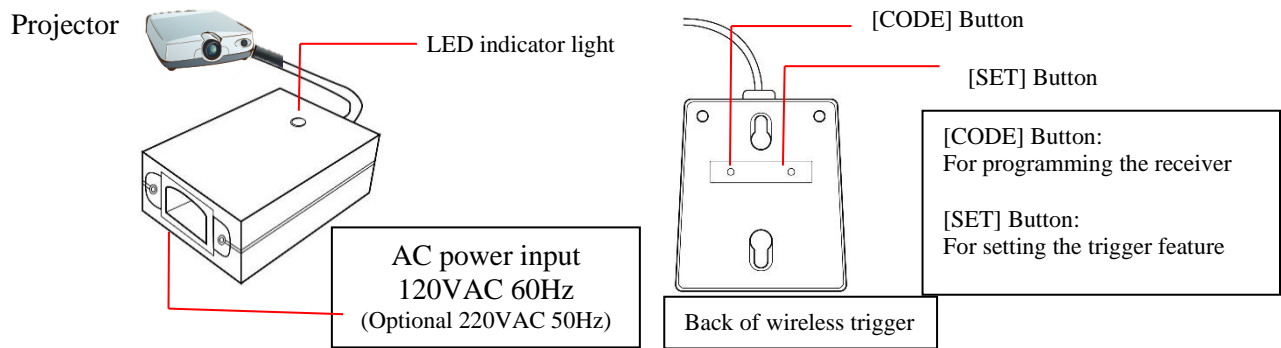

Wireless Trigger Set Up Instructions

A. Wireless trigger and Yard Master Electric projection screen set up [CODE] button:

1. Unplug the Power Cable attached to your motorized Elite Screen from the wall.
2. Connect the Projector's Power Cable to the wireless trigger, then plug the cable into a nearby power outlet.
3. Locate the [CODE] button on the back of the trigger, then, using a small pin, press and hold the [CODE] button.
4. When you see the LED indicator light flashing rapidly, plug the screen's power cord into a nearby outlet. The screen will go up and down slightly. Release the [CODE] button at this point (you may hear a beep sound from the screen).
5. Within 3 seconds after releasing the [CODE] button, press and hold the [CODE] button again until you see the LED indicator light flashing rapidly (the screen will go up and down slightly), this means the synchronization (pairing) process is successful.
6. If unsuccessful repeat from Step 1.

B. Wireless trigger and projector set up [SET] button:

1. Plug the wireless trigger's IEC cable into the projector's power receptacle.
2. Power ON the projector. The screen should drop automatically.
3. Locate the [SET] button on the back of the trigger, then (using a small pin) press and hold the [SET] button for about 3 seconds until LED indicator light flashes and you hear a beep sound.
4. Turn off the projector within 10 seconds after the LED indicator light emits a flash and a beep.
5. At this step in the process, the trigger will record the running current of the projector when it is turned off, and then the process is completed.
6. Power ON the projector. The screen should drop automatically.
7. Power OFF the projector. The screen should retract automatically.
8. If unsuccessful repeat from Step 1.

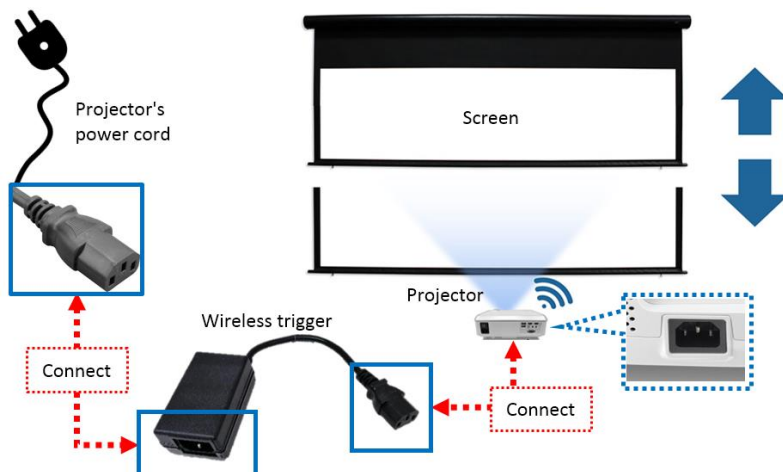

Note

- When powering off the projector, assure it is completely powered off (ex, fan off), then the screen will retract automatically
- If the motorized screen does not automatically drop or retract, repeat the process from Step 1.

Magnetic bottom bracket Installation

1. After the screen is plugged in to a power outlet, press the DOWN button on the RF remote control. Install the magnetic bottom bracket (G) so that the weight bar sleeve cradles inside (see illustration).

Note: The screen should deploy straight down and align with the magnetic bottom bracket (G). Once the weight bar is cradled inside the magnetic bracket, the screen will be secured.

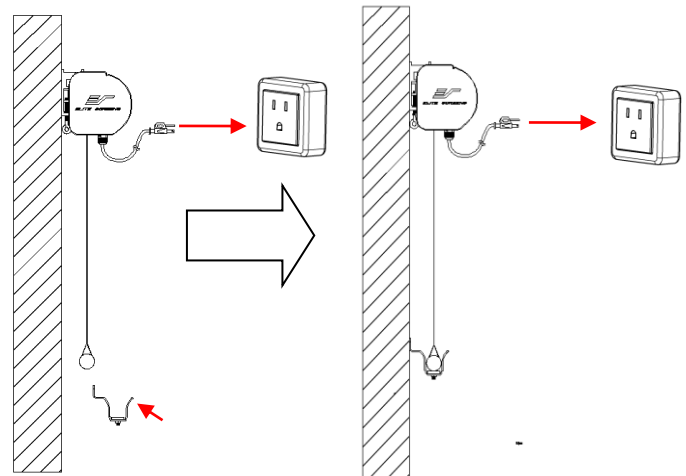

2. Mark the drill-hole area of where the bracket is to be installed with a Marker or Pencil.

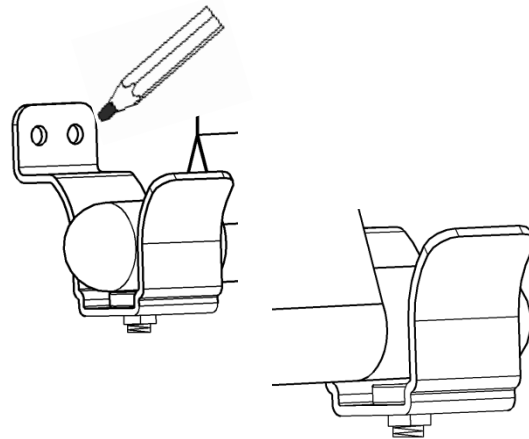
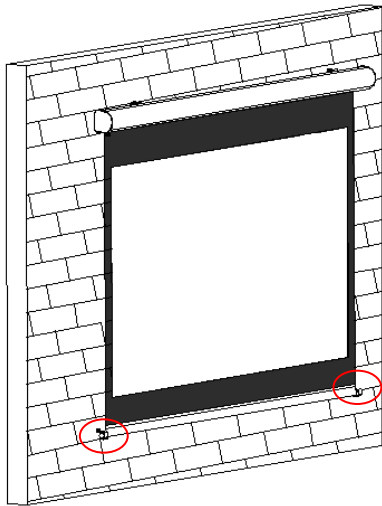

3. Raise the screen UP using the RF remote control. Next, drill holes to insert the **M8x35 Anchor** (C) if installing to a dry wall. Then affix the magnetic bottom bracket (G) on the marked location and secure it with an **M4x35 Screw** (C).

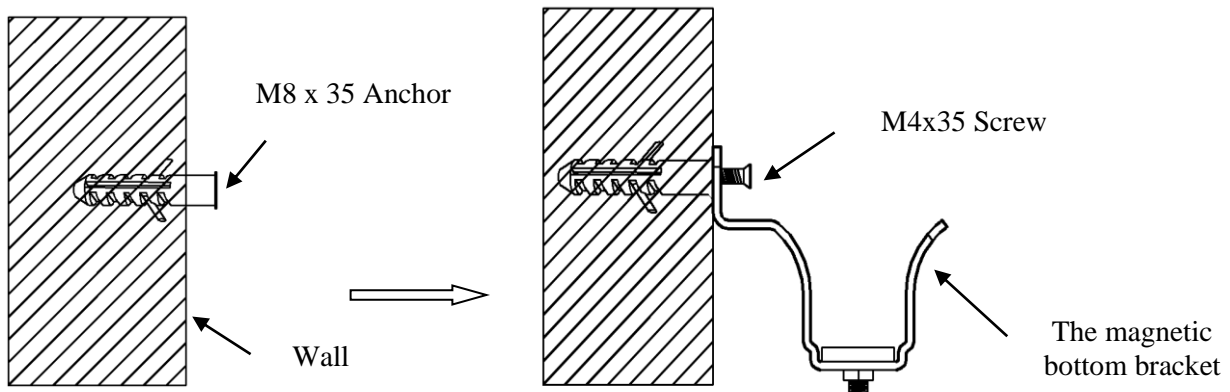

4. Drop the screen DOWN using the RF remote see if the position of the magnetic bottom bracket (G) is correct or not. Reposition the magnetic bottom bracket if needed.

For more information, support or your local Elite Screens contact, please visit www.elitescreens.com