



# Evanescence Tab-Tension B CineGrey 5D® Series

*Recessed In-ceiling Ambient Light Rejecting Projector Screen*

## Installation Guide

### M Type (RC1) – V1.0



Visit [www.elitescreens.com](http://www.elitescreens.com) for latest updated version.

#### **Important Safety & Warning Precautions**

**Make sure to read this user's guide and follow the procedures below.**

In order for the *CineGrey 5D*® to maintain its projection qualities and optimum performance, please refer to the list below for proper maintenance and cleaning.

- Use a dry microfiber cloth to remove dust from the screen's surface.
- When cleaning, use a damp microfiber cloth with warm water to remove any marks.
- Never rub or apply pressure when cleaning the surface.
- Never attempt to use any solutions, chemicals or abrasive cleaners on the screen surface.
- To avoid damaging the screen, avoid touching it directly with your fingers, pens/pencils or any other sharp or abrasive objects.

**Caution:** The screen's Black Top Drop is already set to its maximum drop distance. There is NO extra Black Top Drop in the roller. Unapproved changes or modifications (except for cutting the power cord for hardwire installations) to this unit are prohibited and will void your warranty. For more information, please contact our Technical Support Department at (877) 511-1211 Ext. 604.

- Please retain this user's guide for future reference.
- To avoid damaging the unit, do not use with any unauthorized accessories not recommended by the manufacturer.
- Handle the unit carefully during transportation to avoid any damages.
- To ensure safe and reliable operation, direct connection to a properly grounded power source is advised.
- The power outlet supplying power to the unit should be close to the unit and easily accessible.
- Do not install the unit on uneven, inclined surfaces;
- Do not install in damp places to avoid an electric shock or short circuit.
- Do not place any heavy objects over the power cord.
- Position the power cord properly to avoid creating a trip obstacle.
- To avoid an electrical shock or fire, due to a loose contact or short circuit, do not overload the power cord.
- The internal & external parts of this unit are not end user serviceable. Do not attempt to disassemble this unit by yourself. No one except authorized technicians can open and make repairs to this unit.
- Make sure the power source that this unit is connected to has a continuous power flow.
- If there is need to use an extension cord, make sure the cord has an equal rating as the appliance to avoid over heat.
- Do not handle the power plug when your hands are wet or your feet are in contact with water.
- Properly dispose of this equipment according to the environmental regulations in your area when product is no longer of service.

## Do not use this unit under the following circumstances.

- Disconnect the power cord under the conditions of heavy rain, wind thunder or lightning.
- Avoid direct sun light, rain shower and moisture.
- Keep away from fire sources and high temperature to prevent this device from overheating.
- Cut off the power supply first before transportation or maintenance.
- To avoid possible injury and/or an electric shock, do not attempt to use this screen if there is obvious damage or if there are any evident broken parts.

## Installation Warning

The instructions provided in this user's guide are for reference only. Please consult a professional installation company for further installation and safety advice. The installer must insure that proper mounting hardware is used to provide adequate strength suitable for the installation. Elite Screens is not liable for any faulty installations.

**NOTE:** This equipment has been tested and found to comply with the limits for a Class B digital device, pursuant to Part 15 of the FCC Rules.





These limits are designed to provide reasonable protection against harmful interference in a residential installation. This equipment generates and can radiate radio frequency energy and, if not installed and used in accordance with the instructions, may cause harmful interference to radio communications.

However, there is no guarantee that the interference will not occur on a particular installation. If this equipment causes harmful interference to radio or television reception, which can be determined by turning the equipment off and on, the user is encouraged to try to correct the interference by one or more of the following measures.

- ✓ **Reorient or relocate the receiving antenna of the device which may be causing the interference.**
- ✓ **Increase the separation between the screen and the device's receiver.**
- ✓ **Connect the equipment into a different power outlet other than the device.**

## Pre-Installation

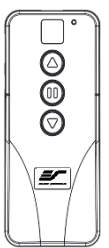
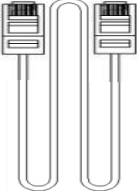
1. Carefully unpack the screen.
2. Always handle the screen in a leveled position on a clean surface.
3. In order to protect the screen from exposure to stains, keep the screen out of contact with foreign particles such as dust, sawdust, and/or liquids.

Evanesce Tab-Tension B CineGrey 5D® Series   Controls and Accessories				
A. IR Remote ZRC1-IR-W1	B. RF Remote ZRC1-RF-W1	C. Wall box controller ZRC-WB-W1	D. RJ50 cable ZRC1-RJ50	H. Bubble leveler
				

## Screen operation

**Electric Current:** The screen operates on AC110V at 60Hz/ 1.18A

1. After ensuring the power outlet & screen are compatible (voltage), plug the power cord into the power outlet.
2. Once the screen has power, you'll be able to control it using any of the 5 methods described below.
3. **IR and RF remote controls require 2x AAA batteries (not included).**

## 5 Ways to control your screen

**1. IR Remote control (Item A, Fig 1):** The Infrared functions by direct line of sight contact using an effective beam range of 25 feet within a 30-degree angle. Aim the IR remote directly at either the IR receiver on the Wall Box Controller or on the screen to operate the screen.



**Note:** Assure there is no obstruction between the IR remote and IR receiver.

**2. RF Remote Control (Item B):** The radio waves eliminate the need for a direct line of sight and has a longer distance control range.

The RF remote is already pre-synced/paired and ready to use. If synchronization/ pairing is needed, please follow the steps below.

### How to synchronize/pair a new RF remote:

- Press & hold the “**Programming Key**”, then press the “**Up Key**” on the **Wall box controller** (wall-box LED flashes). *Reference the wall box controller section for programming key location.*
- Then press the “**Up Key**” on the **RF remote**.
- The **Wall box** LED will flash 5 times, to indicate the RF remote has been properly synchronized/paired.

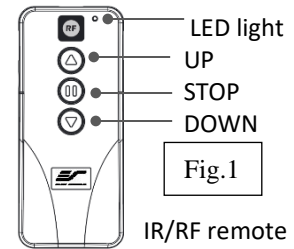

### How to change the RF code (For use when multiple screens/RF remotes are owned)

Changing the RF code avoids controlling multiple screens at the same time and prevents electrical interference leading to accidental control of the screen.

1. Remove the batteries
2. Change the RF code switch
3. Insert the batteries
4. Synchronize it with the wall box controller

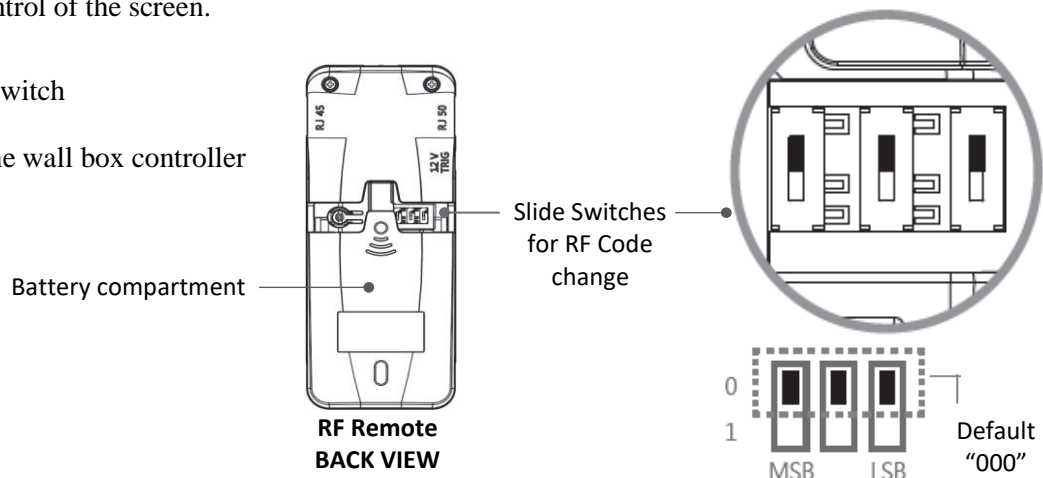

**3. Wall box controller (Item C, Fig 2):** The wall box controller switch is a wall mounted control box with an up/stop/down button. It plugs directly into the screen’s RJ50 port.

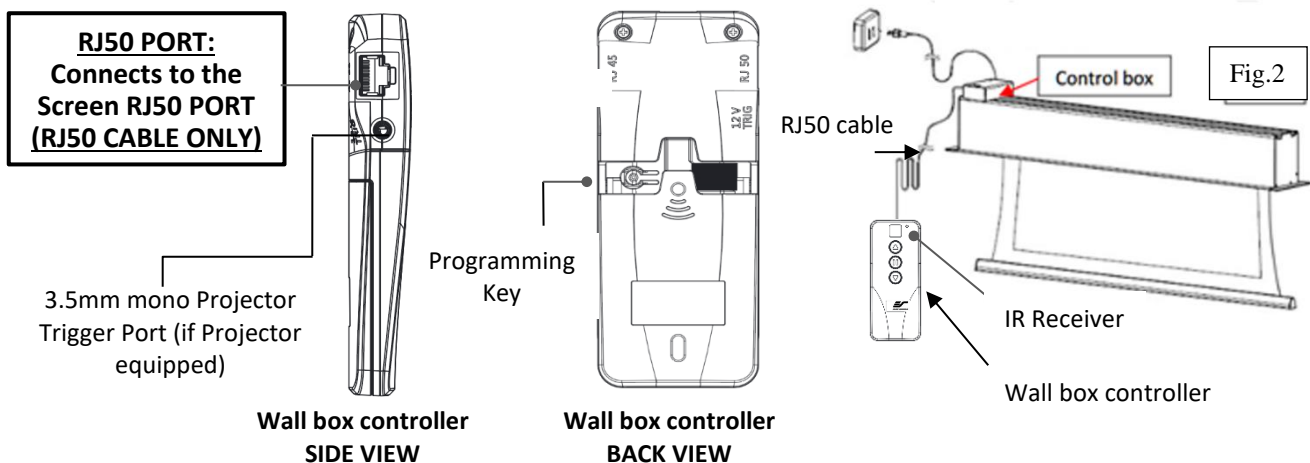

**4. Wired 5-12 volt trigger (Fig. 3):** Requires a 3.5mm to 3.5mm mono cable (not included)

**Step 1:** Connect one end the RJ50 cable to the screen and the other end to the Wall box controller.

**Step 2:** Then connect one end the 3.5mm mono cable to the wall box controller and the other to the projector. Once the two cables have been connected, the wired trigger feature is ready to synchronize the screen's up/down operation with the projector's power cycle.

- Projector on, screen drops
- Projector off, screen raises

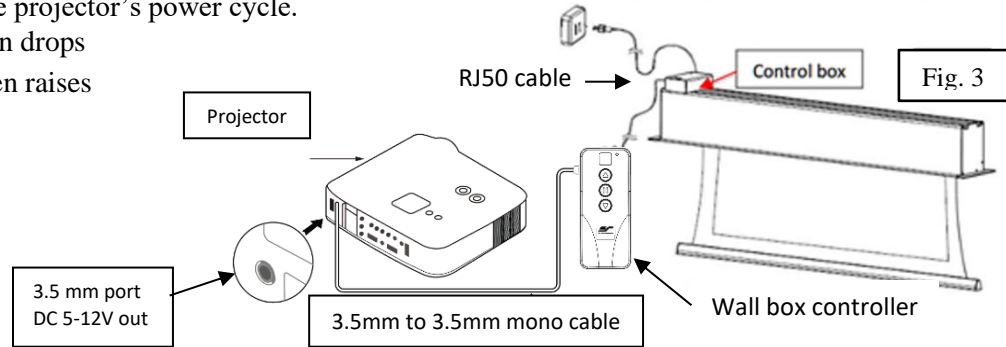

**5. Wireless 5-12 volt trigger (Fig 4):** Requires a 3.5mm to 3.5mm mono cable (not included).

The Radio Frequency (RF) remote control serves as a dual purpose, independently as a handheld remote control, or as a Wireless 5-12 volt trigger. The radio frequency technology sends a wireless signal that synchronizes the screen's drop & rise with the projector's power cycle.

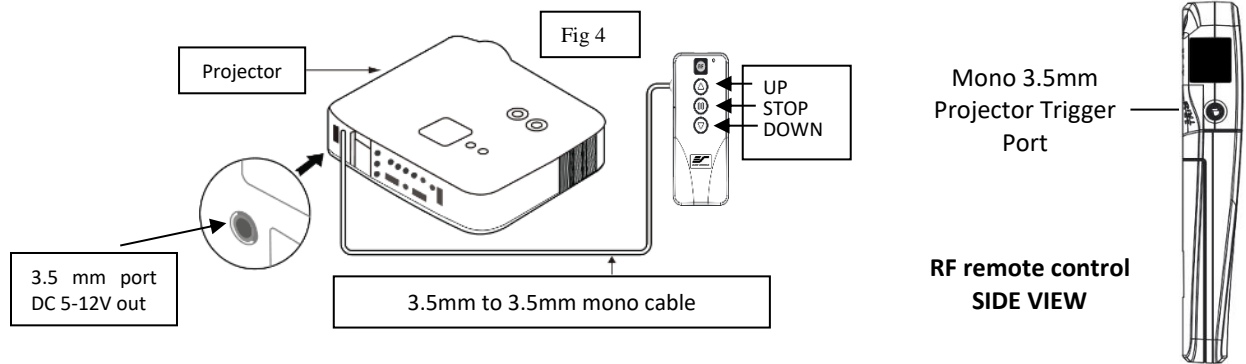

**Here's how to set up your Wireless 5-12 volt trigger**

The 5-12V wireless trigger should already be synced and ready to work.

**Step1:** Connect one end of the 3.5 mm mono trigger cable to the RF remote.

**Step 2:** Connect the other 3.5 mm mono end of the cable to your projector

**Step 3:** Turn on the projector and the screen should automatically deploy.

**Step 4:** Turn off your projector and the screen should automatically retract.

*(Please be aware, the projector on/off cycle may take longer to fully activate. It usually takes around 20- 30seconds for full off and on cycle each time)*

**Note:** If the wireless trigger feature does not work, please resync the RF remote to the Wall box controller per the instructions in the Radio Frequency remote section.

**ADVANCED Programming Key Instructions: (FOR ADVANCED USERS ONLY)**

Wall box controller must be connected to the screen.

**ATTENTION:** Reducing the factory's full screen drop may produce waves/wrinkles on the projection surface on tab-tension screens. The full drop is recommended to allow the screen to rely on the tab-tension system to maintain the projection surface flat and taut on all sides.

The same applies on non-tensioned screens, although some level of waves may be present due to the nature of the screen not being tensioned. If wrinkles/waves develop after making the adjustment to the desired drop position, reset it to the factory's default position per the instructions below.

**FLATNESS AFFECTED BY NEW PROGRAMMED VERTICAL POSITION IS NOT COVERED UNDER A REPLACEMENT WARRANTY.**

**1. Preset the Screen’s Drop Position:**











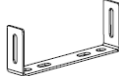
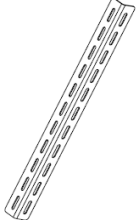

Use the RF/IR remote or Wall Box Controller to Drop the screen to the desired position you want to set it at. Press & hold the “**Programming Key**”, then press the “**Down key**” on the Wall Box Controller. The LED will flash 5 times to confirm the new programmed drop position.

**PROGAMMING NOTE:**

The programmed vertical position relies on a time-count which adjusts itself according to the programmed timed difference. Multiple up/down programming will result in the vertical position being off a few inches. It is recommended that programming is done the **first-time** the desired vertical position is determined or **RESET** it to factory default and programming the desired vertical position afterwards.

**2. Clear/Reset the Screen’s Drop Position to factory default:**

Press & hold the “**Programming Key** + “**Stop key**” on the wall box controller.

Hardware Parts List for Polar Max Recessed Series			
A. Case Rail Nut x 4 	B. Hex Screw x 4 	C. Hanging Bracket x 2 	D. Suspension Bar x 4 
E. Washer x 8 	F. Hex Nut x 4 	G. M8 Top Expanding Bolt x 4 	
I. M8 Screw Nut x 20 	J. M8 Hexagonal Screw x 4 	K. M8 Screw Washer x 28 	H. M8 Threaded Rod x 4 
L. Installation Bracket x 2 	M. Socket Wrench x 1 	N. White cover flange panel x 2 	

*Please make sure all parts listed below are included before proceeding with the installation.*

**Installation Instructions**

The Evanesce Tab-Tension B CineGrey 5D® allows access for above or below ceiling installation. Please follow the instructions described in the following steps below for your type of installation.

**Power**

The Evanesce Tab-Tension B CineGrey 5D® includes a 3-Prong Power Cord (2-Prong Power Cord for some countries) for use in a non-concealed power outlet. If your installation will be entirely concealed (including power outlet), Elite Screens strongly recommends a hardwire connection. Please refer to the image below for both 110v & 220v wiring information.

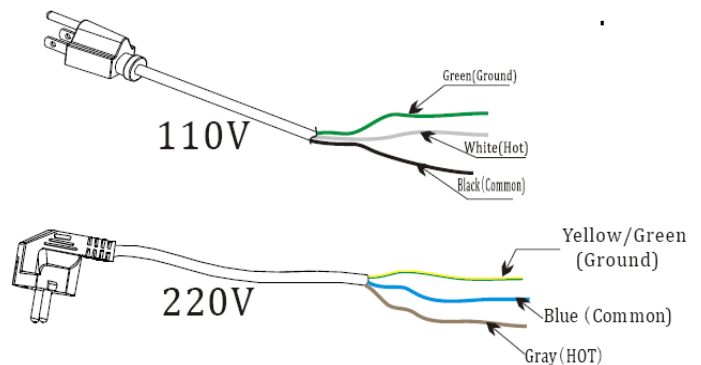

## Notice to Installer:

Please use the following installation instructions to obtain superior optical performance from the CineGrey 5D® Angular Reflective ALR (Ambient Light Rejecting) Screen.

Make sure to follow these instructions in order for the CineGrey 5D® to perform correctly.

- Angular-Reflective material is not compatible with ultra/short-throw projectors
- Minimum lens throw ratio 1.5x image width
- Ambient light must not come from the same direction as the projector

*Since angular-reflective means that the projected image will reflect at the mirror-opposite angle, it is important to position the projector so that the viewer will get the best possible image.*

**Step 1:** Establish the general “eye level” of the viewers

**Step 2:** Set the appropriate projection level

**Step 3:** Adjust the screen height level and projection angle

Input Angle (A) = Output Angle (B) aligns with the viewer’s angle

### Correct Installation Examples

**Projector Ceiling Installation:** Make sure the projector (*light in*) is angled (A) to reflect (B) at the mirror-opposite angle (*light out*) to align with the viewer’s eye level.

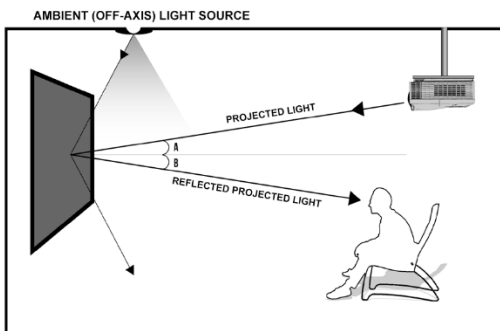

**Projector Table Top:** Make sure the projector (*light in*) is angled (A) to reflect (B) at the mirror-opposite angle (*light out*) to align with the viewer’s eye level.

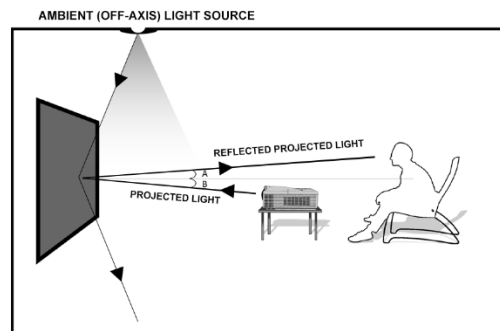

### Incorrect Installation Examples

**Ceiling Mounted Short-throw Projector**

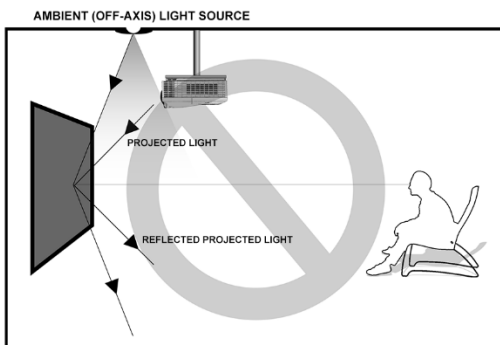

**Tabletop Ultra-Short throw Projector**

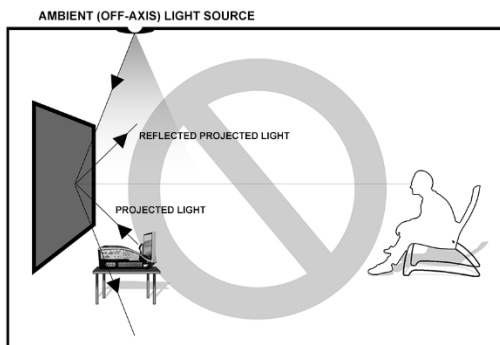

**Note:** Improper installation will result in light loss and produce a dark image. This is due to the projector’s light reflecting in the wrong direction.

*Images are not up to scale and are for illustration purposes only.*



3. Install the screen to the screw bolt as shown in the figure below.

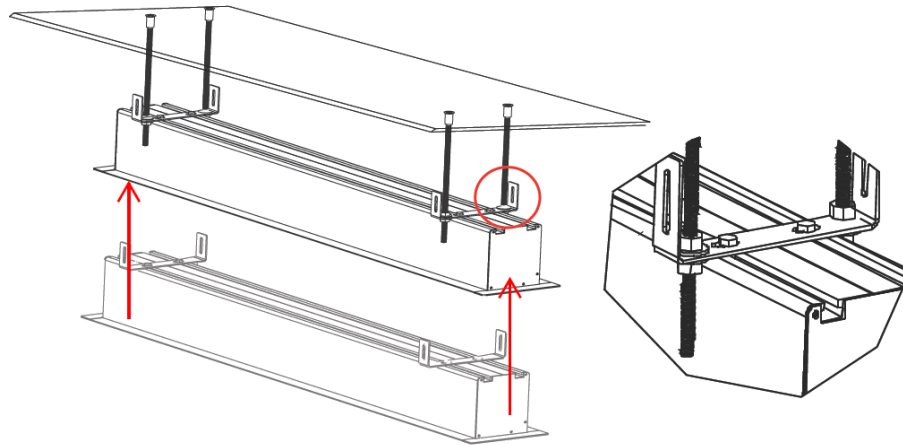

## B. Below ceiling installation instructions

1. Measure and cut the ceiling installation space. The width should not exceed 120mm. Measure the length of your screen to determine the length.

Note: The length of the installation space is not greater than the screen size table (A3), and the width is not less than the screen size table (A5). Consult the table below (C1) in regards to accommodating the screen casing.

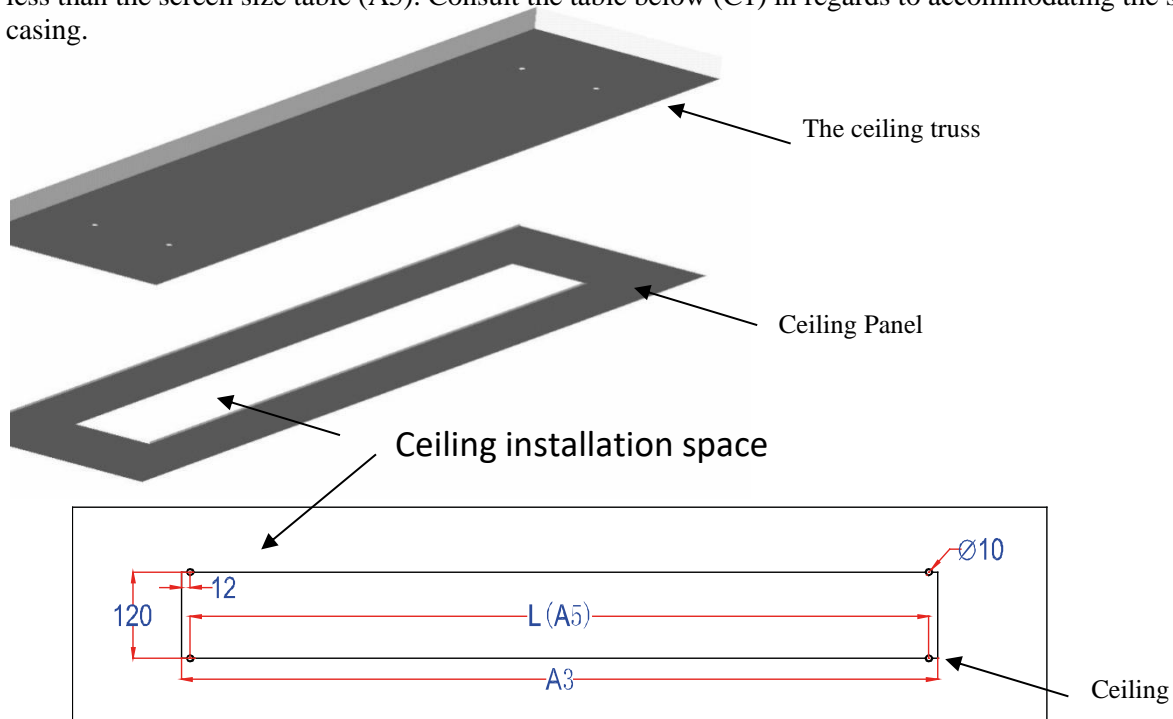

2. Drill 4 holes in the ceiling that correspond with the attachments on the various casing sizes.

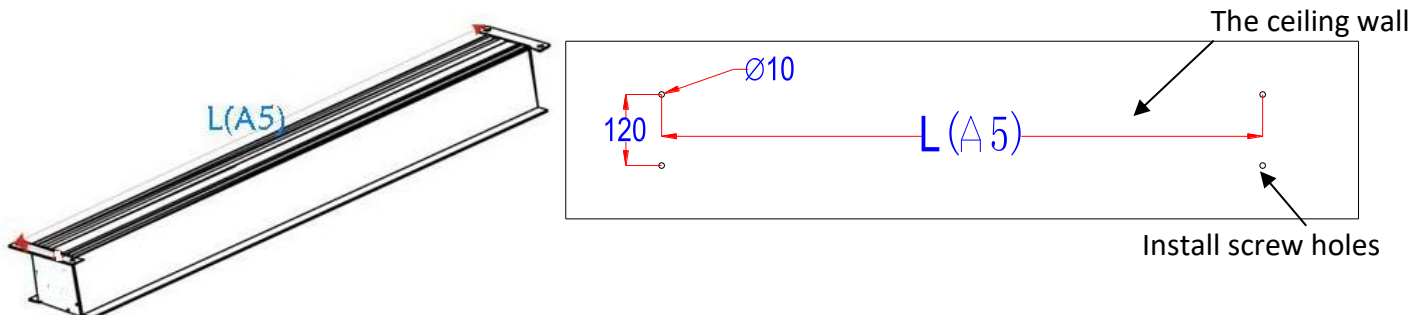



3. The expanding bolts (G) mount into thick wood beams, stone or concrete and will support the screen. Use the Socket wrench (M) to attach the hexagonal screws (J). The expanding bolts should be firmly tightened and tested to make sure that they will hold the weight of the screen.

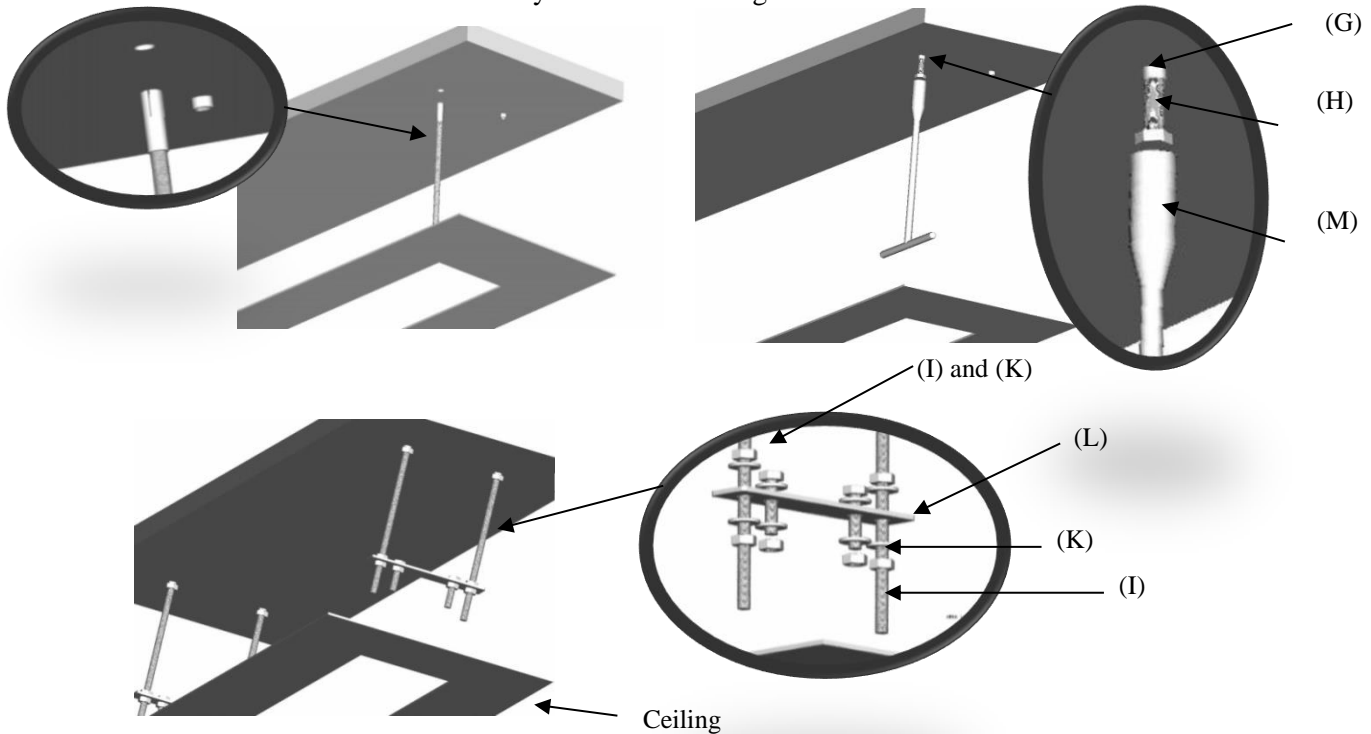

4. Push the screen up into the space. Use the threaded rods (H) to attach the screen assembly to the ceiling. The hexagonal screws (J) will connect the screen to the rest of the assembly. Once firmly in place, use the nuts (I) to ensure a firm connection. Use the socket wrench (M) to make sure that the bolts are firmly tightened.

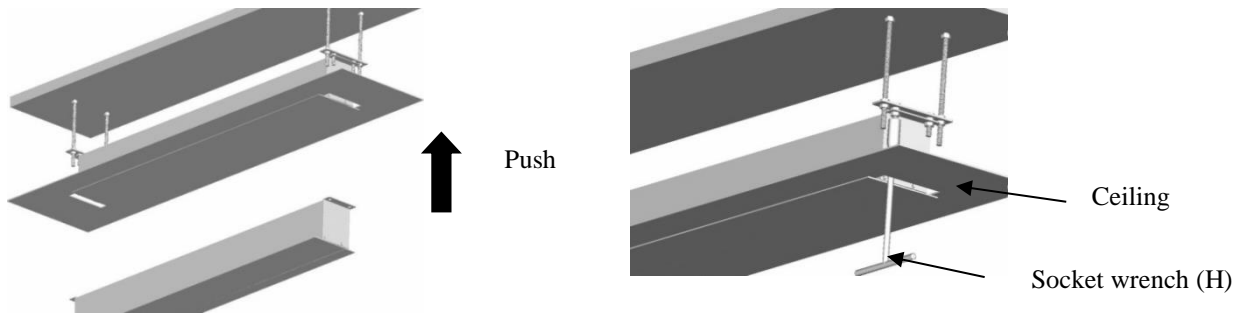

5. Install plastic cover panel (N) to complete the installation.

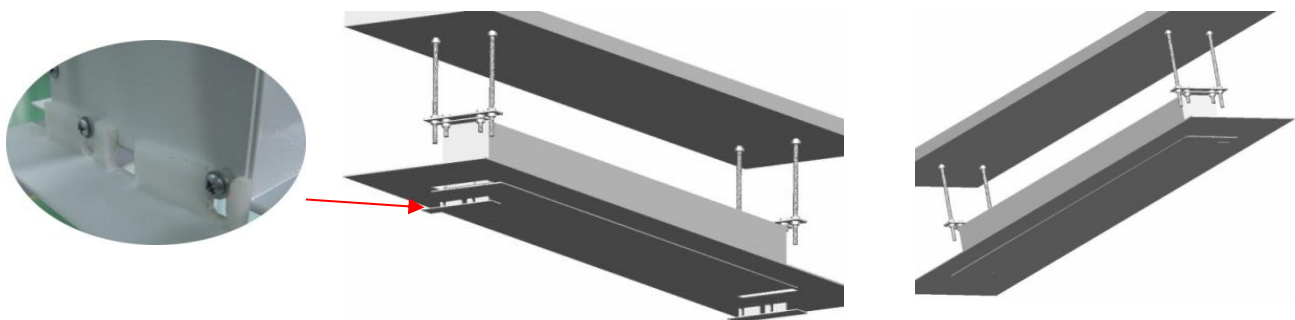

For local Elite screens contact or Technical Support, please visit [www.elitescreens.com](http://www.elitescreens.com)