



## Spectrum Series

### Electric/Motorized Projector Screen

## User's Guide – E/H Type (RC1)

V1.1

Visit [www.elitescreens.com](http://www.elitescreens.com) for the latest updated version.

### **Important Safety & Warning Precautions**

*Make sure to read this user's guide and follow the procedure below.*

#### **SCREEN MAINTAINANCE**

**Dust, dirt and scratches on the projection screen surface will affect the quality and performance of the projection image. For optimal results we advise to pay attention to the following instructions.**

1. Materials needed: Two Lint-Free white cloths, Mild Soap (hand soap is suitable) and Water.
2. Take the Lint-Free cloth and submerge it in warm water for cleaning light dust and dirt. For stubborn stains or a sticky surface, a solution of hand soap diluted with warm water should be used.
3. Completely ring out cloth so it is lightly dampened, not drenched.
4. Using the damp cloth, lightly wipe in an up and down motion starting at the left of the screen moving to the right of the screen. **DO NOT WIPE IN CIRCULAR MOTION.**
5. Once you have completed wiping the entire screen with a dampened Lint-Free cloth, use the dry Lint-Free cloth to wipe off any excess water from the screen

**Notes:** *The following precautions should be followed to avoid damaging the material, which is not covered under warranty.*

- Don't scratch the material, as it will leave permanent markings on the screen's surface.
- Don't point to the screen material with a fingertip or other sharp objects to prevent damage to the material.
- Don't use acetone, benzene, alcohol and any other organic solvents to clean the screen material. Using such chemicals will permanently damage the screen.

**Caution:** The screen's Black Top Drop is already set to its maximum drop limit. There is NO extra black-matte drop material on the roller. Please be aware that altering the vertical limit switch to drop the screen material off the roller voids your warranty with Elite Screens. Unapproved changes or modifications (except for cutting the power cord for hardwire installations) to this unit are prohibited and will likewise void your warranty.

- Please retain this user's guide for future reference.
- To avoid damaging the unit, do not use with any unauthorized accessories not recommended by the supplier.
- Handle the unit carefully during transportation to avoid any damages.
- To ensure safe and reliable operation, direct connection to a properly grounded power source is advised.
- The power outlet supplying power to the unit should be close to the unit and easily accessible.
- Do not install the unit on uneven or inclined surfaces.
- Do not put heavy objects on the power cord and position it properly to avoid creating a trip obstacle.
- Never overload the power cord to prevent an electric shock or fire due to a loose contact or a short circuit.
- There are not user serviceable parts in this unit. Do not attempt to disassemble this unit by yourself. No one except authorized technicians can open and make repairs to this unit.
- Make sure the power source this unit is connected to has a continuous power flow.
- If there is need to use an extension cord, make sure the cord has an equal rating as the appliance to avoid overheat.
- Do not handle the power plug when your hands are wet or your feet are in contact with water.

**Do not use this unit under the following circumstances.**

- Disconnect the power cord under the conditions of heavy rain, wind, thunder or lightning.
- Avoid direct Sunshine, rain shower and moisture.
- Keep away from fire sources and high temperature to prevent this device from overheating.
- Cut off the power supply first before transportation or maintenance.
- Fully disconnect from the power supply when the unit is not in use for a long period of time, as should be done with any other electric household appliance.
- To avoid possible injury and/or an electric shock, do not attempt to use the screen if there is obvious damage or if there are any evident broken parts.

**NOTE:** This equipment has been tested and found to comply with the limits for a Class B digital device, pursuant to Part 15 of the FCC Rules.

These limits are designed to provide reasonable protection against harmful interference in a residential installation. This equipment generates and can radiate radio frequency energy and, if not installed and used in accordance with the instructions, may cause harmful interference to radio communications.

However, there is no guarantee that the interference will not occur on a particular installation. If this equipment causes harmful interference to radio or television reception, which can be determined by turning the equipment off and on, the user is encouraged to try to correct the interference by one or more of the following measures.

- ✓ **Reorient or relocate the receiving antenna of the device which may be causing the interference.**
- ✓ **Increase the separation between the screen and the device's receiver.**
- ✓ **Connect the equipment into a different power outlet other than the device.**

### **Pre-Installation**

1. Carefully unpack the screen.
2. Always handle the screen in a leveled position on a clean surface.
3. In order to protect the screen from exposure to stains, keep the screen out of contact with foreign particles such as dust, sawdust, and/or liquids.

### **Installation Instructions**

**Note:** Regardless of the mounting method, the screen should be securely supported so that the vibration or pulling on the viewing surface will not cause the casing to become loose or fall.

Included are complimentary mounting screws that may or may not be appropriate for the installation you are attempting. Always use the correct anchors to safely secure the screen.

1. Select the installation location for your screen. Ensure that it is within reasonable proximity from your power source.
2. For best support of your screen, it is ideal to secure your screen into the studs of your house's internal framework. If studs are not available, use hollow anchors for mounting your wall screws into drywall. If you're installing in a concrete structure, use concrete bolts to secure your screen.
3. Ensure that both brackets are in perfect level alignment with one another. Use wall/ceiling wood screws to secure to the wood studs. Use hollow anchors if mounting in drywall.
4. The screen casing is designed to accept the wall screws directly, be sure to position a washer between the head of the wall-screw and the anchor slots on the screen's casing.
5. Using a tape measure, mark the keyholes that are located at the back of the screen's casing end cap.
6. After marking the area and predrilled hole, insert the screw and have at least 1/8" from the wall/ceiling to mount the screen. **(See example in Figure 1.)**
7. **Figure 3** will show you an optional installation using chains (not included)

#### **A. Flush wall installation using the back screw holes on the end cap brackets.**

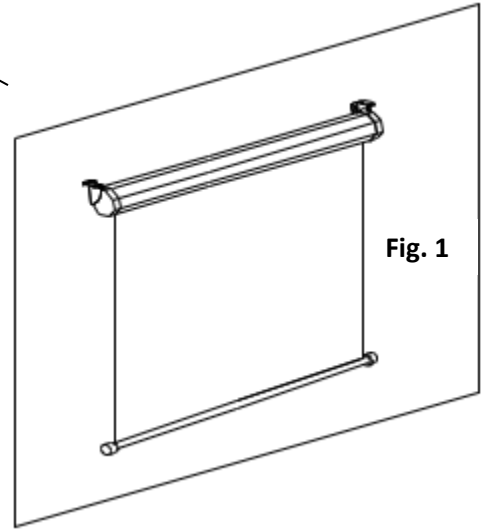
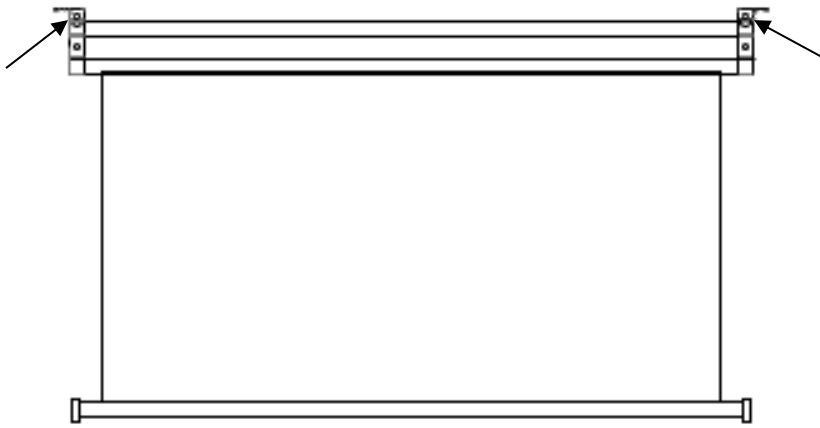



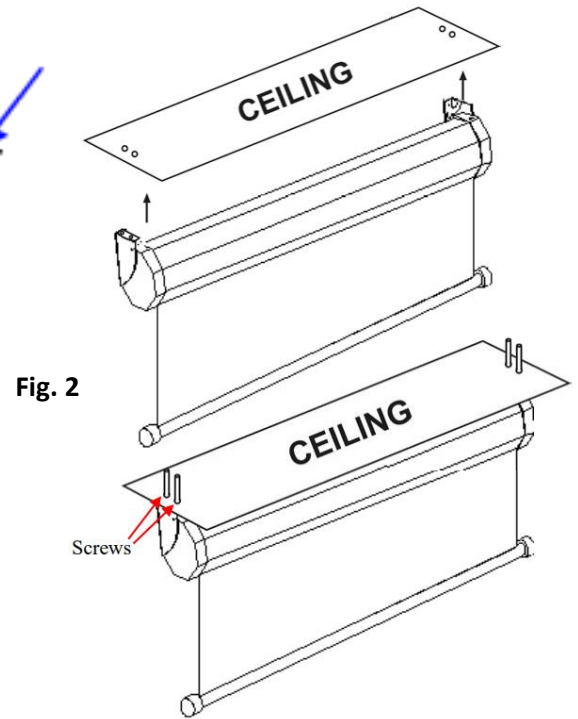
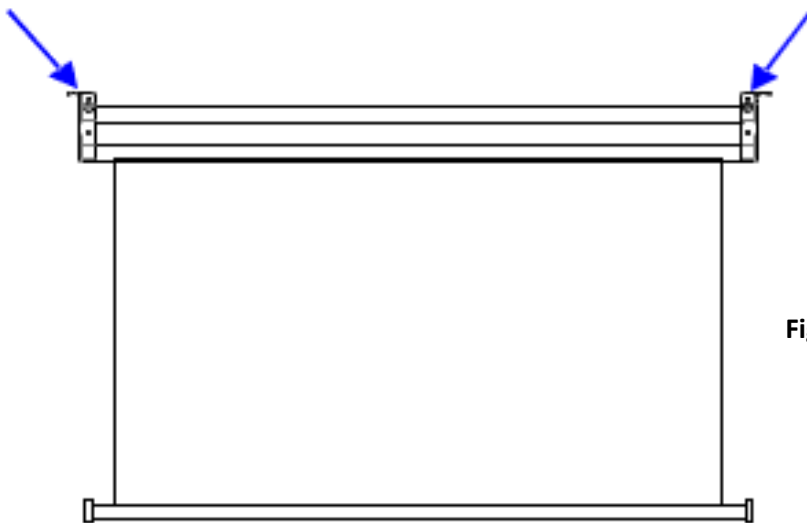

**B. Flush ceiling installation using the top screw holes on the end cap brackets.**

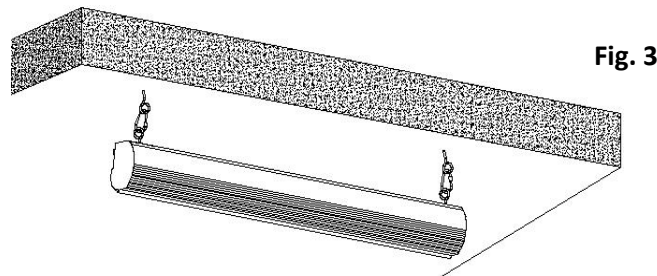

**C. Optional installation method using a chain to hang the screen from the ceiling. Chains not included.**

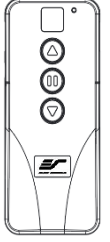
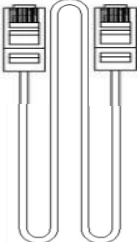

**Spectrum Series | Controls and Accessories**

A. IR Remote ZRC1-IR	B. RF Remote ZRC1-RF	C. Wall box controller ZRC1-WB	D. RJ50 cable ZRC1-RJ50	G. AAA batteries	H. Bubble leveler
					

## Screen operation

**Electric Current:** 110v.

1. After ensuring the power outlet & screen are compatible (voltage), plug the power cord into the power outlet.
2. Once the screen has power, you'll be able to control it using any of the 5 methods described below.

## 5 Ways to control the screen

**1. IR Remote control (Item A, Fig 1):** The Infrared functions by direct line of sight contact using an effective beam range of 25 feet within a 30-degree angle. Aim the IR remote directly at either the IR receiver on the Wall Box Controller or on the screen to operate the screen.

**Note:** Assure there is no obstruction between the IR remote and IR receiver.

**2. RF Remote Control (Item B):** The radio waves eliminate the need for a direct line of sight and has a longer distance control range.

The RF remote is already pre-synced/paired and ready to use. If synchronization/pairing is needed, please follow the steps below.

### How to synchronize/pair a new RF remote:

- Press & hold the “**Programming Key**”, then press the “**Up Key**” on the **Wall box controller** (wall-box LED flashes). *Reference the wall box controller section for programming key location.*
- Then press the “**Up Key**” on the **RF remote**.
- The **Wall box LED** will flash 5 times, to indicate the RF remote has been properly synchronized/paired.

### How to change the RF code (For use when multiple screens/RF remotes are owned)

Changing the RF code avoids controlling multiple screens at the same time and prevents electrical interference leading to accidental control of the screen.

1. Remove the batteries
2. Change the RF code switch
3. Insert the batteries
4. Synchronize it with the wall box controller

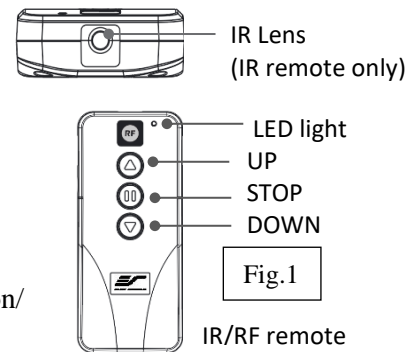
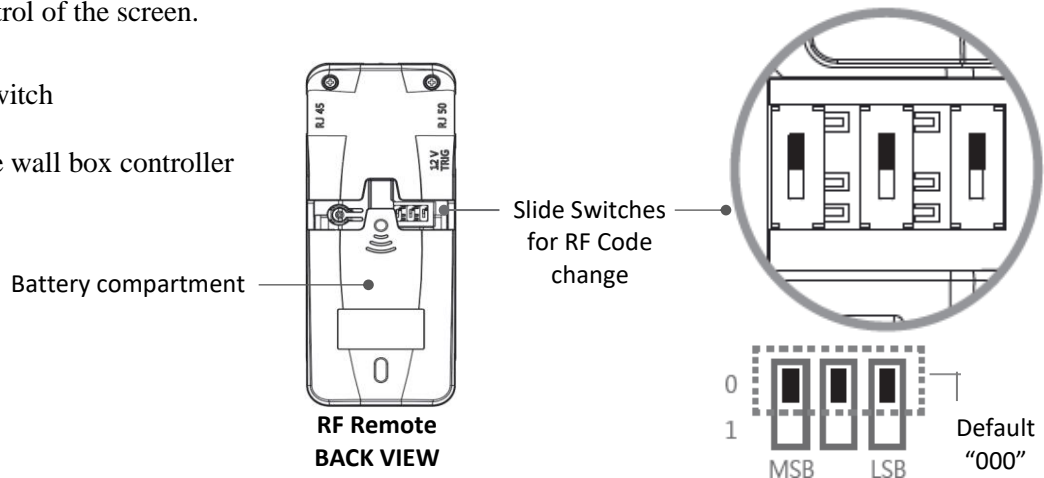

**3. Wall box controller (Item C, Fig 3):** The wall box controller switch is a wall mounted control box with an up/stop/down button. It plugs directly into the screen's RJ50 port.

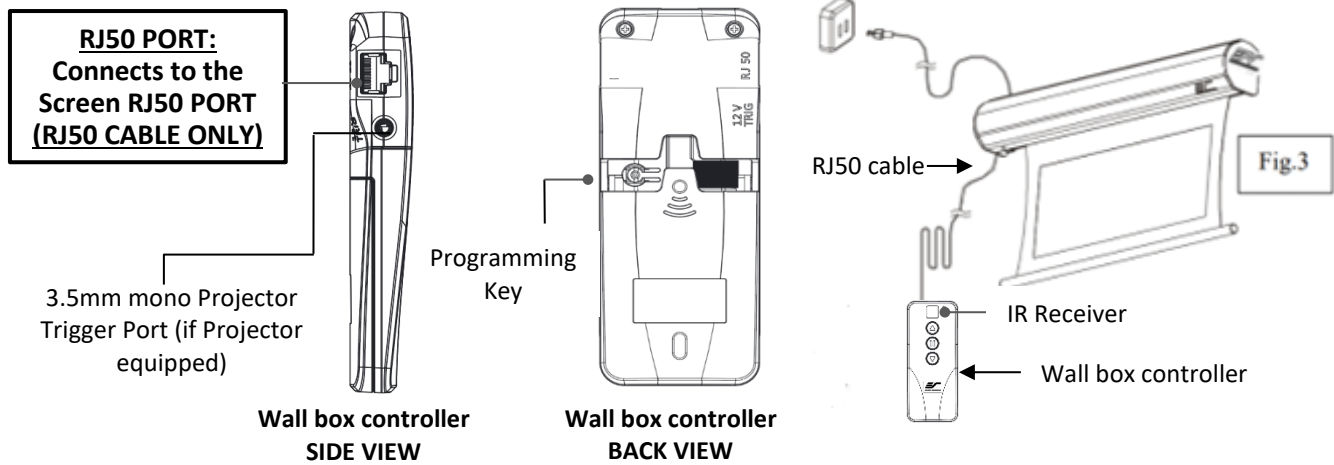

**4. Wired 5-12 volt trigger:** Requires a 3.5mm to 3.5mm mono cable (not included)

**Step 1:** Connect one end the RJ50 cable to the screen and the other end to the Wall box controller.

**Step 2:** Then connect one end the 3.5mm mono cable to the wall box controller and the other to the projector.

Once the two cables have been connected, the wired trigger feature is ready to synchronize the screen's up/down operation with the projector's power cycle.

- Projector on, screen drops
- Projector off, screen raises

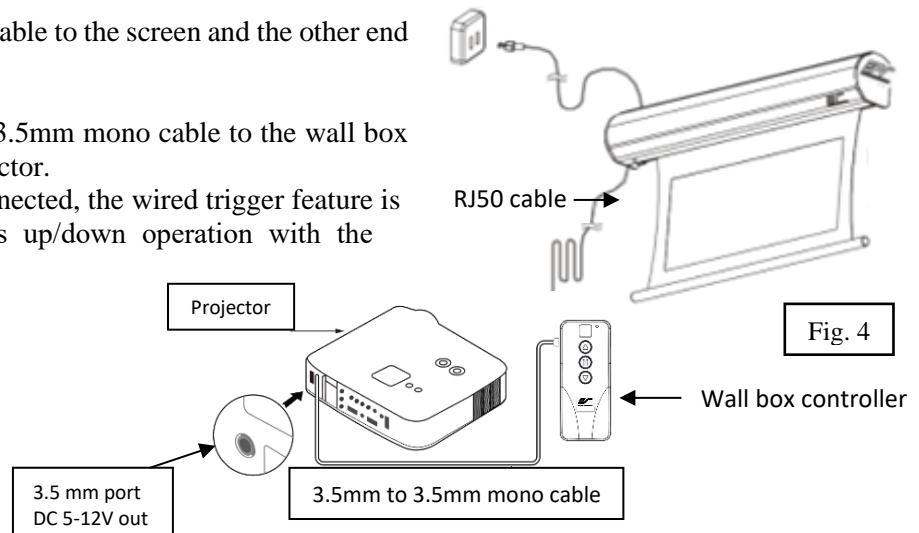

**5. Wireless 5-12 volt trigger (Fig 5):** Requires a 3.5mm to 3.5mm mono cable (not included).

The Radio Frequency (RF) remote control serves as a dual purpose, independently as a handheld remote control, or as a Wireless 5-12 volt trigger. The radio frequency technology sends a wireless signal that synchronizes the screen's drop & rise with the projector's power cycle.

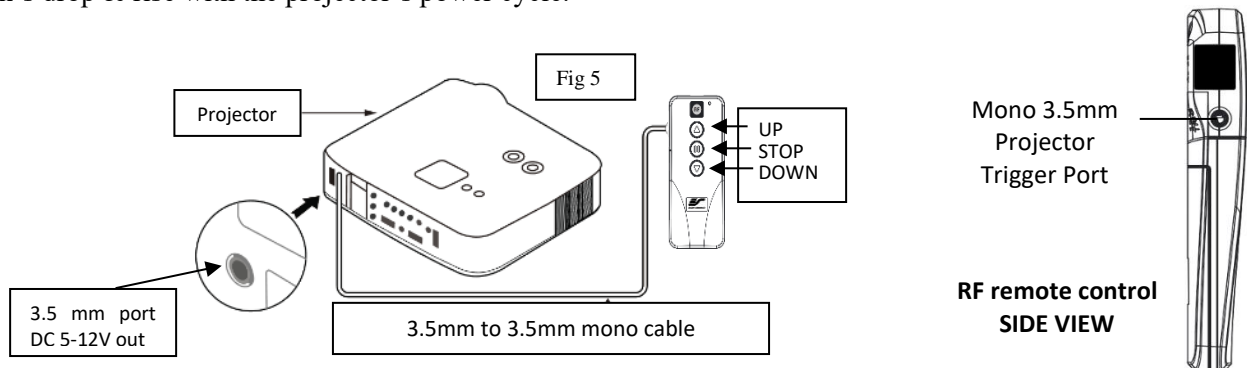

### **Here's how to set up your Wireless 5-12 volt trigger**

The 5-12V wireless trigger should already be synced and ready to work.

**Step 1:** Connect one end of the 3.5 mm mono trigger cable to the RF remote. 

**Step 2:** Connect the other 3.5 mm mono end of the cable to your projector 

**Step 3:** Turn on the projector and the screen should automatically deploy.

**Step 4:** Turn off your projector and the screen should automatically retract.

*(Please be aware, the projector on/off cycle may take longer to fully activate. It usually takes around 20-30seconds for full off and on cycle each time)*

**Note:** If the wireless trigger feature does not work, please resync the RF remote to the Wall box controller per the instructions in the Radio Frequency remote section.

### **ADVANCED Programming Key Instructions: (FOR ADVANCED USERS ONLY)**

Wall box controller must be connected to the screen.

**ATTENTION:** Reducing the factory's full screen drop may produce waves/wrinkles on the projection surface on tab-tension screens. The full drop is recommended to allow the screen to rely on the tab-tension system to maintain the projection surface flat and taut on all sides.

The same applies on non-tensioned screens, although some level of waves may be present due to the nature of the screen not being tensioned. If wrinkles/waves develop after making the adjustment to the desired drop position, reset it to the factory's default position per the instructions below.

**FLATNESS AFFECTED BY NEW PROGRAMMED VERTICAL POSITION IS NOT COVERED UNDER A REPLACEMENT WARRANTY.**

#### **1. Preset the Screen's Drop Position:**

Use the RF/IR remote or Wall Box Controller to Drop the screen to the desired position you want to set it at. Press & hold the "**Programming Key**", then press the "**Down key**" on the Wall Box Controller. The LED will flash 5 times to confirm new programmed drop position.

#### **PROGRAMMING NOTE:**

The programmed vertical position relies on a time-count which adjusts itself according to the programmed timed difference. Multiple up/down programming will result in the vertical position being off a few inches. It is recommended that programming is done the **first-time** the desired vertical position is determined or RESET it to factory default and programming the desired vertical position afterwards.

#### **2. Clear/Reset the Screen's Drop Position to factory default:**

Press & hold the "**Programming Key** + "**Stop key**" on the wall box controller.



# SHORT THROW PROJECTION DISCLAIMER

Using a *short throw projector* on a *non-tensioned* type screen will result in image distortion as the slightest wave on the viewing surface will become more evident.

For *short throw projectors*, Elite Screens recommends the use of a **motorized tab-tensioned, fixed frame or whiteboard** projection screen.

Examples of undoctored projection images using a *standard throw* and *short-throw* projector

*Standard throw* projected image shown below (waves are not visible)

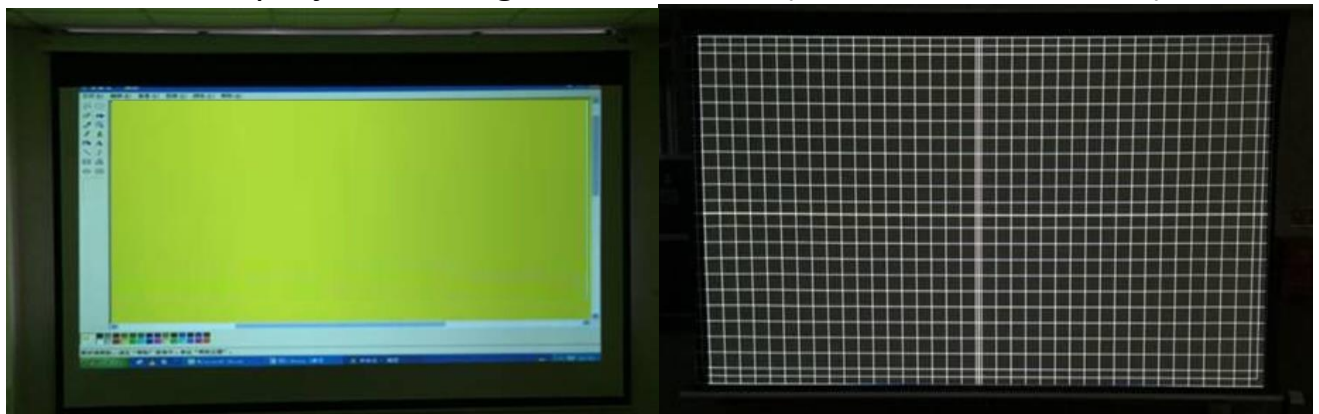

This *short throw* projected image shown below, demonstrates how waves on the surface become more pronounced:

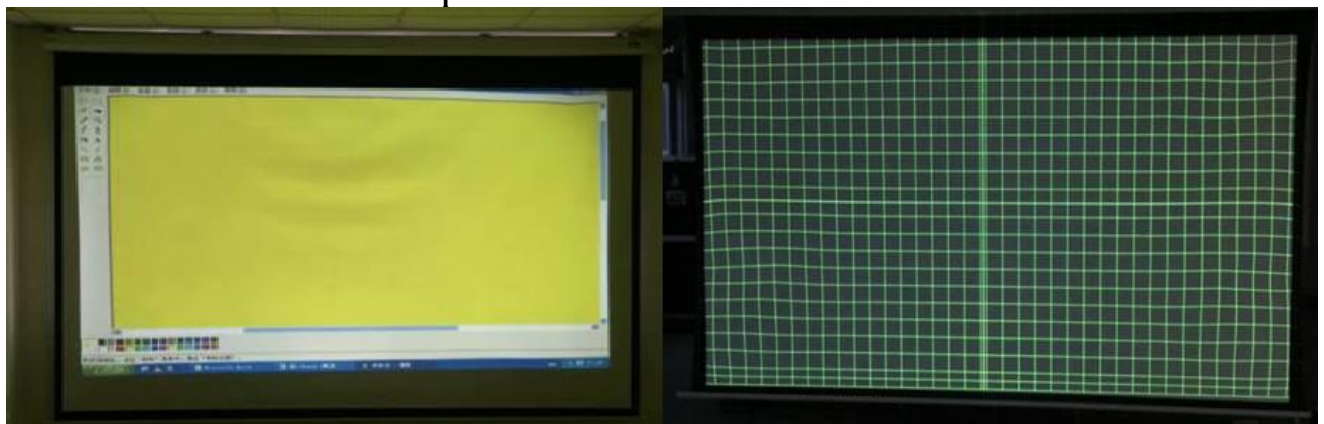

Actual Projection Images by two different projectors on same screen model with ***Standard Throw Projector*** (Model #:ViewSonic Pro8300) vs. ***Short-Throw Projector*** (Model #:BenQW710ST)

# **DIRECT SUNLIGHT DISCLAIMER**

Projection Screens from any maker are not designed for use as a window curtain and should never be exposed to direct sunlight. Prolonged exposure to solar radiation will destroy synthetic materials and such damage is not covered by our standard warranty.

See examples below.

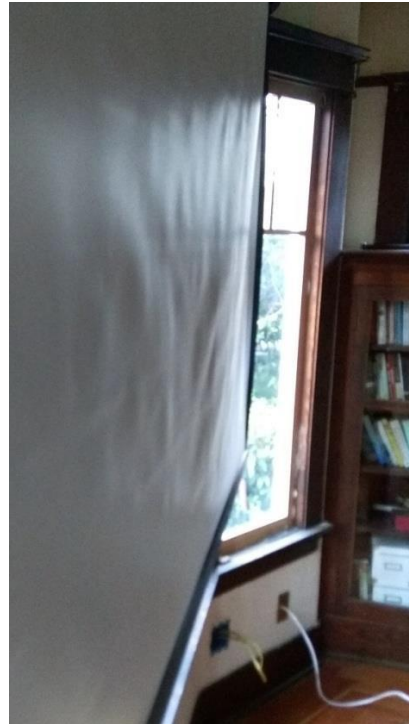

**For more information, technical support or your local Elite Screens contact, please visit [www.elitescreens.com](http://www.elitescreens.com)**